

150.2400 | 4-Hole Deck Mounted Roman Tub Filler With Hand Held Shower



SPECIFICATIONS:

- Solid Brass construction - includes valves
- Four Hole Installation
- Flow Rate = 7.0 GPM @ 60 PSI
- Hand Shower Flow Rate = 1.8 GPM @ 60 PSI
- Diverter controls water flow between spout and hand held

STANDARDS:

- ASME A112.18.1 / CSA B125.1

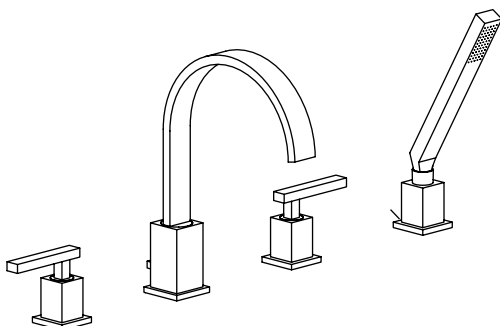

Technical Diagram

